

**GEBRAUCHSANLEITUNG**  
**INSTRUCTIONS**  
**INSTRUCTIONS**  
**INSTRUCCIONES**  
**ISTRUZIONI**

**next**<sup>®</sup>

*the next less'n'more gmbh*  
*Scheidtweilerstrasse 79*  
*D-50933 Köln*

*Tel.: +49 (0)221-999844-80*  
*Fax: +49 (0)221-999844-88*

*info@less-n-more.com*  
*www.next.design*  
*www.less-n-more.com*

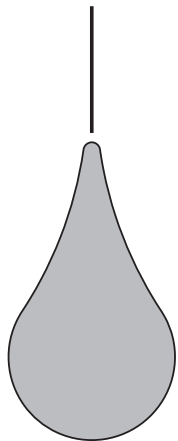

**DROP-2S-L-IP44**

CE □ IP44 E27

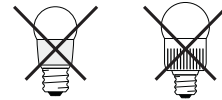

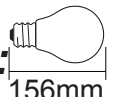
**DROP-2L:**  **max. 100W**

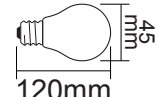
**DROP-2S:**  **max. 100W**



**LEBENSGEFAHR!** Stromkreis abschalten und gegen Wiedereinschalten sichern! **SICHERHEITSHINWEISE** beachten!  
**DANGER TO LIFE!** Disconnect power supply and secure it against inadvertent reconnection! Observe **SAFETY INSTRUCTIONS!**  
**RISQUE DE MORT!** Couper le circuit de courant et bloquer contre la remise en marche! Respecter les **NOTICES DE SÉCURITÉ!**  
**PELIGRO DE MUERTE!** Desconectar el circuito eléctrico y asegurarlo contra una nueva conexión! Observar las **INDICACIONES DE SEGURIDAD!**  
**PERICOLO DI MORTE!** Disinserire l'alimentazione elettrica e assicurare contro la riaccensione! Osservare le **INDICAZIONI DI SICUREZZA!**

**1**

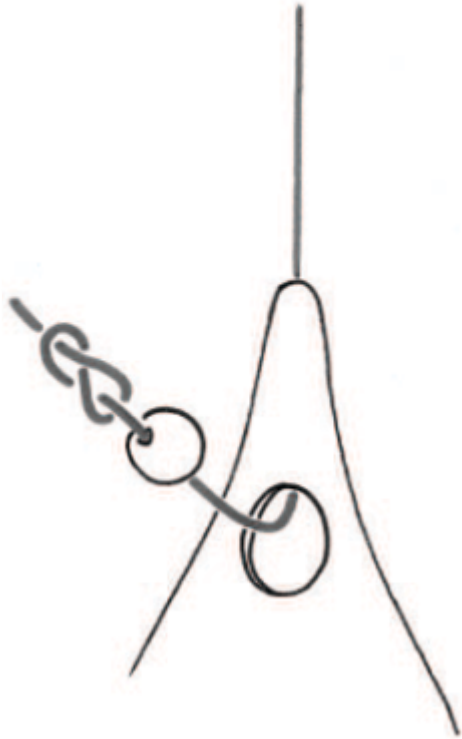

**2**

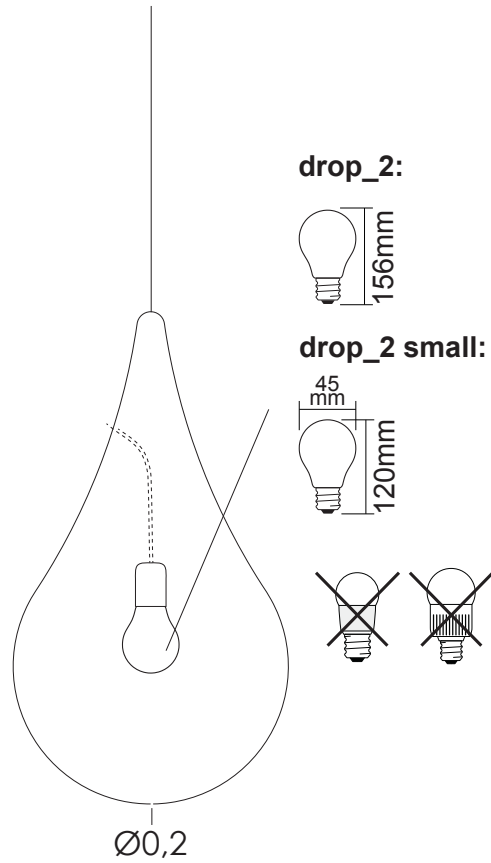

Entwässerungsbohrung offen halten  
Keep drainage hole open

**3**

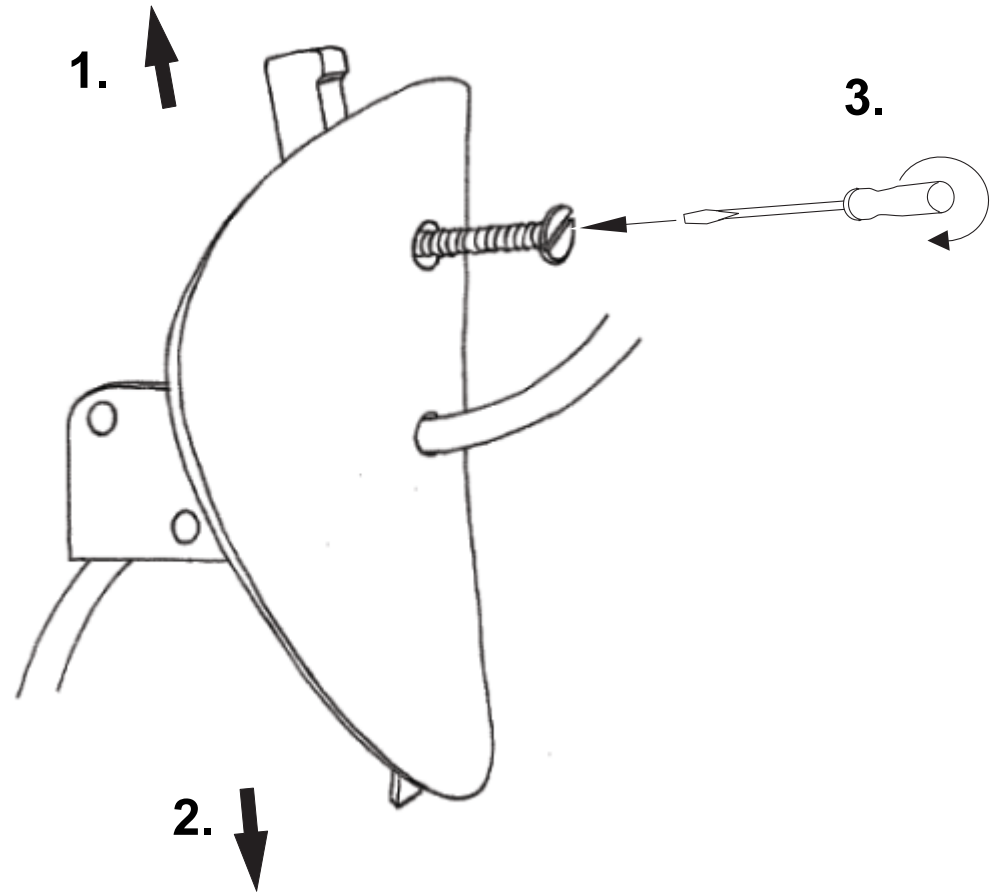

Kabellänge zwischen Deckel und Fassung nicht verändern!  
Don't change length of the cable between cap and lampsocket!